

Club Notes:



December 2010

The Busy Season Here!

You know how each of you has been completely covered up with “I gotta have this for Christmas” quilts? Well, that has had an immediate and overwhelming affect on Sweet Dreams Quilt Studio, too! The result of the Christmas rush quilts is that there are 193 patterns in this batch. Since that’s more than double the normal number of patterns, I thought it was noteworthy. The number of patterns has been steadily increasing as more and more quilters join the Crown Jewels Club, but really....this is almost overwhelming.

So, do yourselves a favor and give your customers a deadline so you don’t find yourselves still quilting for your customers on Christmas eve!

I actually quilted a little wall hanging for myself (hostess gift for my daughter’s future mother-in-law who doesn’t do any sewing at all!). It kind of reminded me why I bought my first longarm machine!

Warm Wishes,
Kim and Janet

The Emerald Princess contains 193 patterns, including 421 panos, a retail value of \$2135.00



Panos



Pattern: arrowhead pano 001
Archive: Emerald Princess



Pattern: asian pano 001
Archive: Emerald Princess



Pattern: baseball fun 008
Archive: Emerald Princess

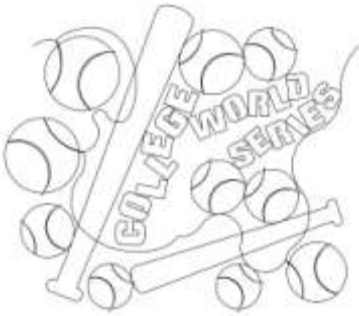

Pattern: baseball fun 009
Archive: Emerald Princess

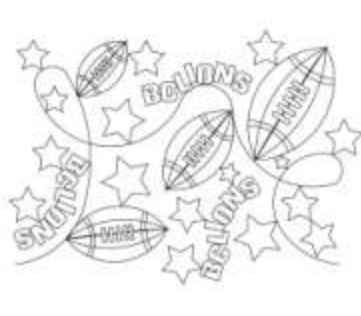

Pattern: bclions
Archive: Emerald Princess



Pattern: beaver pano 001
Archive: Emerald Princess

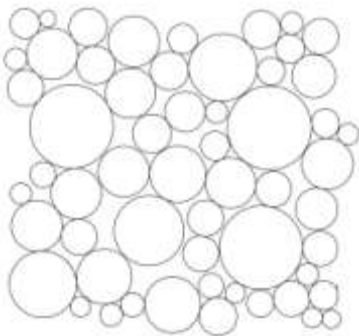

Pattern: bubbles everywhere 002
Archive: Emerald Princess



Pattern: bulldog pano 002
Archive: Emerald Princess

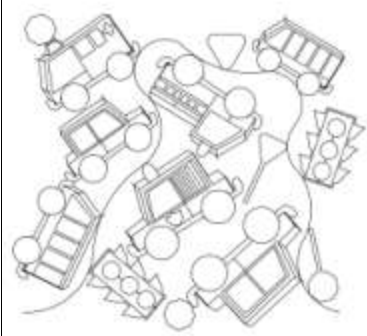

Pattern: cars on the go pano 001
Archive: Emerald Princess

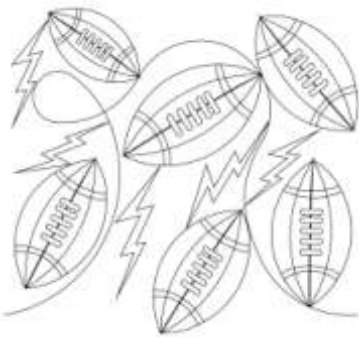

Pattern: chargers football pano
Archive: Emerald Princess

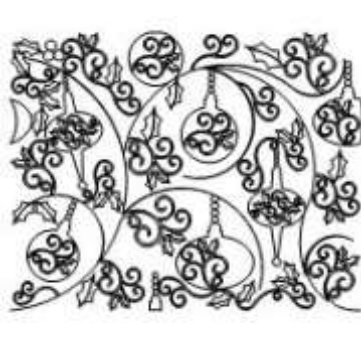

Pattern: christmas 2010 pano 001
Archive: Emerald Princess



Pattern: country mouse pano
Archive: Emerald Princess

Panos Cont.



Pattern: cystic fibrosis pano
Archive: Emerald Princess



Pattern: deer in the trees 002
Archive: Emerald Princess



Pattern: electric pano 001
Archive: Emerald Princess

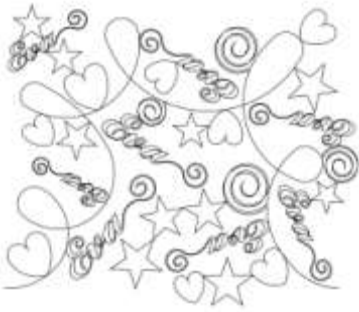

Pattern: eva pano
Archive: Emerald Princess



Pattern: folk art flower pano 001
Archive: Emerald Princess



Pattern: go gators
Archive: Emerald Princess



Pattern: go sioux pano
Archive: Emerald Princess

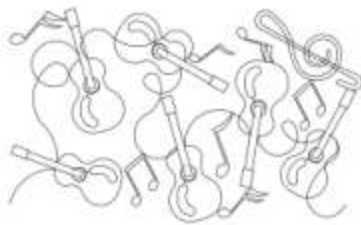

Pattern: guitar pano 003
Archive: Emerald Princess



Pattern: leaf pano 005
Archive: Emerald Princess



Pattern: m hearts pano
Archive: Emerald Princess



Pattern: macaenzie pano
Archive: Emerald Princess

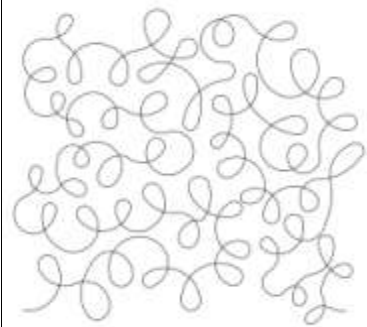

Pattern: meandering loops 001
Archive: Emerald Princess

Panos Cont.



Pattern: mexican hat dance pano
Archive: Emerald Princess



Pattern: monster pano 001
Archive: Emerald Princess



Pattern: nutzman pano
Archive: Emerald Princess



Pattern: petunia city
Archive: Emerald Princess

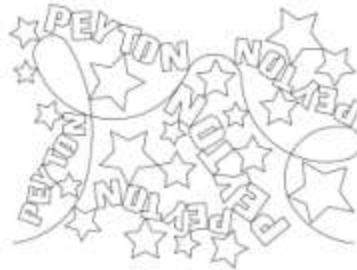

Pattern: peyton pano
Archive: Emerald Princess



Pattern: political pano 001
Archive: Emerald Princess



Pattern: rescue 911 pano 001
Archive: Emerald Princess



Pattern: ribbon dance pano 007
Archive: Emerald Princess



Pattern: ribbon ou
Archive: Emerald Princess



Pattern: safari pano 001
Archive: Emerald Princess



Pattern: safari pano 002
Archive: Emerald Princess

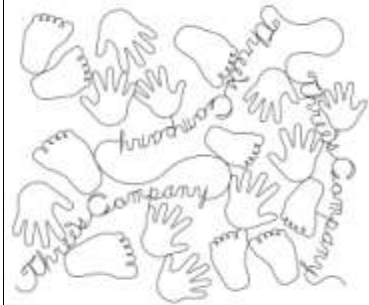

Pattern: threes company
Archive: Emerald Princess

Panos Cont.



Pattern: tigers pano 001
Archive: Emerald Princess

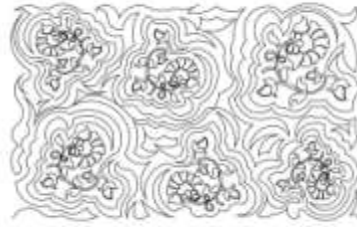

Pattern: turkish pano sq
Archive: Emerald Princess



Pattern: wine 101
Archive: Emerald Princess



Pattern: wolf in trees 002
Archive: Emerald Princess

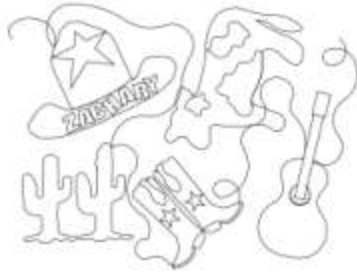

Pattern: zachary pano
Archive: Emerald Princess



It took us awhile to get it done, but you can now keep up with new patterns, Crown Jewels Club release dates, photos from our customers.... We'll be using it to make announcements to our longarm quilting customers and share ideas and kudos among us all!

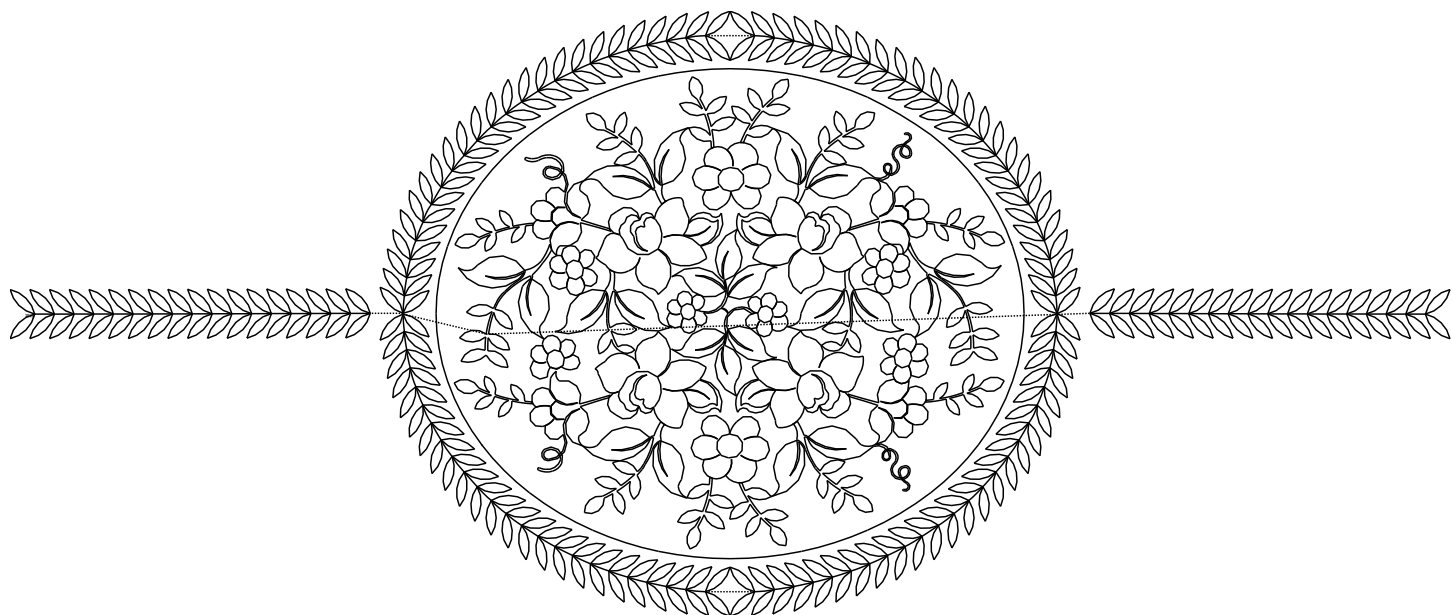

Use this piece in the Georgette's Legacy Quilt whole cloth quilt to make a lap quilt for an adult.

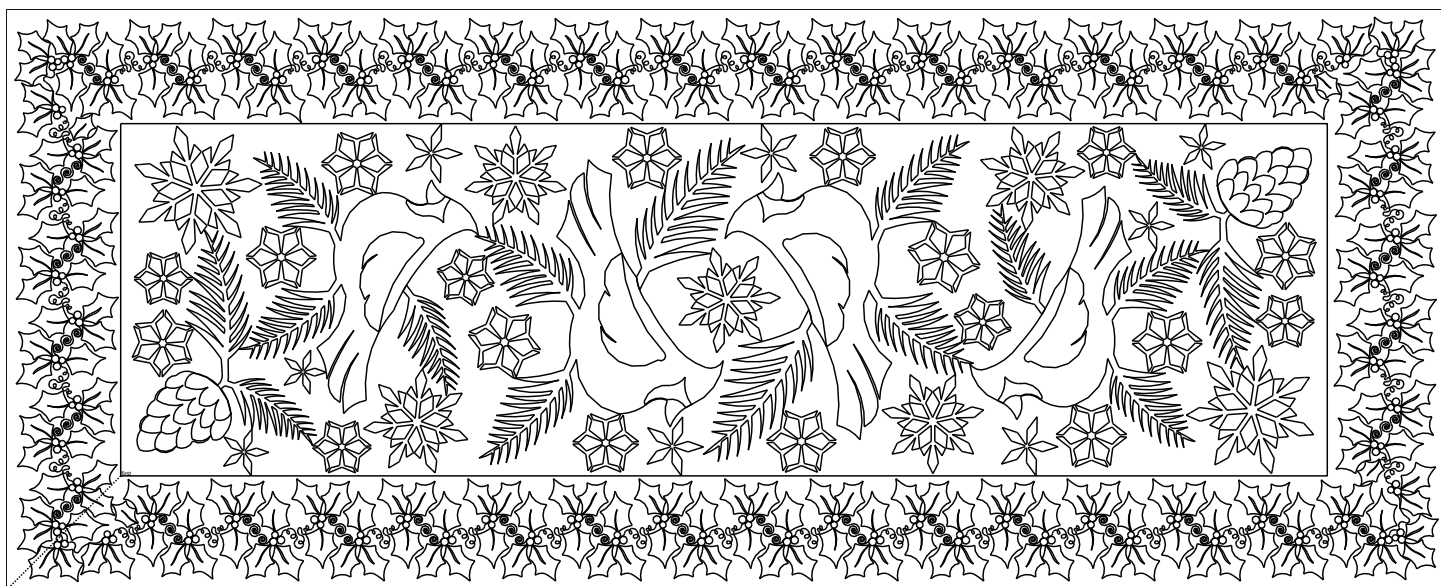

Quilt this pattern out to create an easy gift or just for yourself. Although it was designed for a customer who wanted it for Christmas gifts, it isn't necessarily a Christmas table runner. I plan to quilt it out on Michael Miller's Fairy Frost fabrics and have it as a winter table runner.

Christmas Stockings

New Format

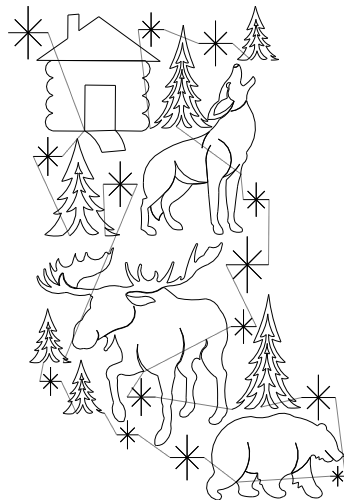
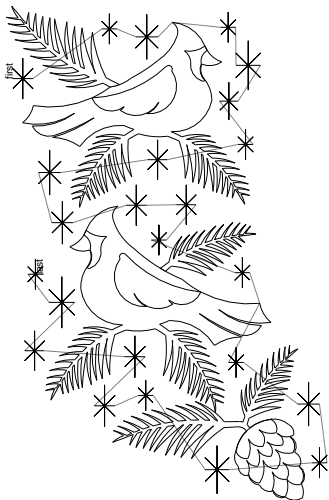
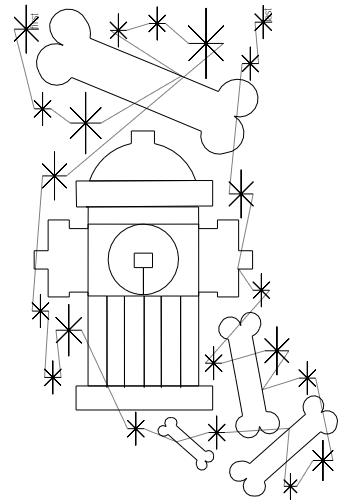

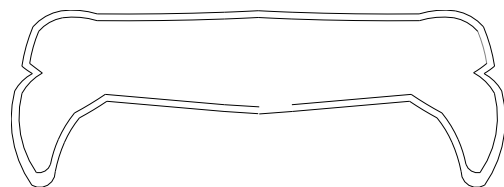
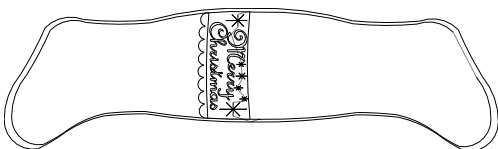
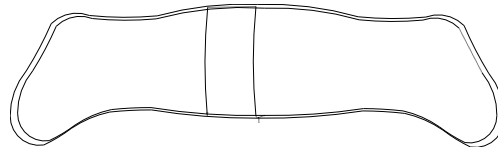
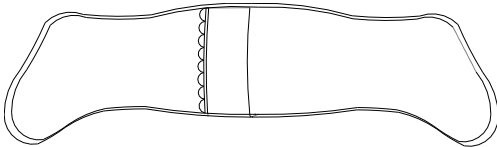
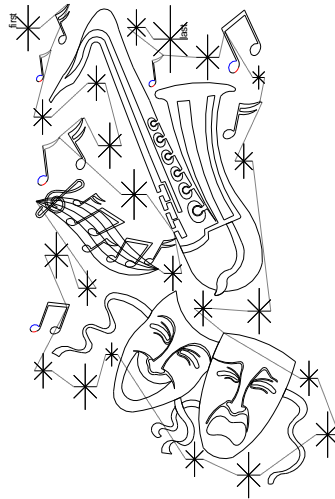
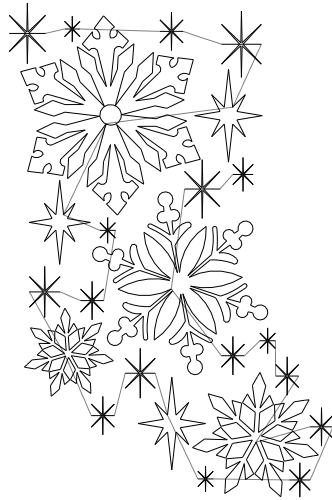
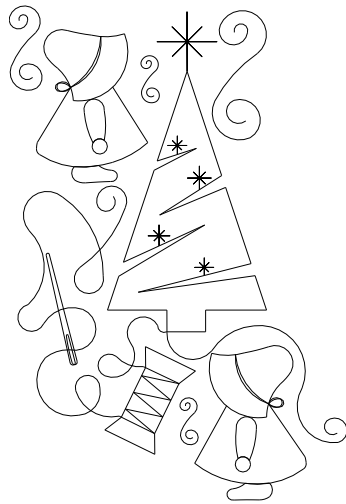
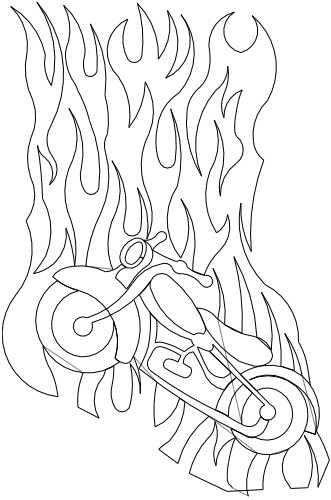
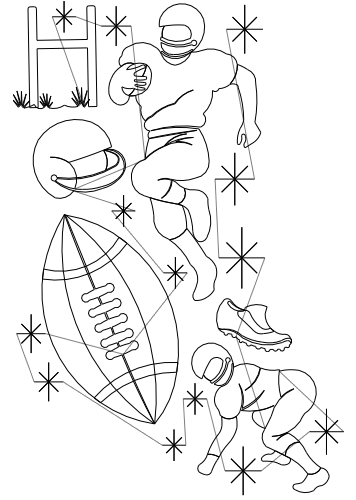
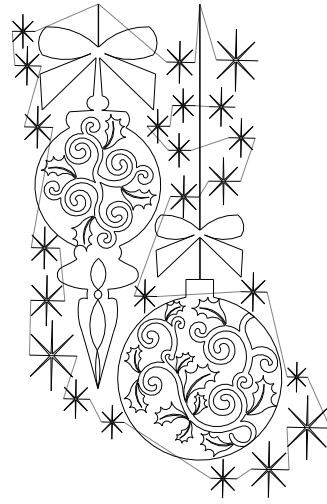
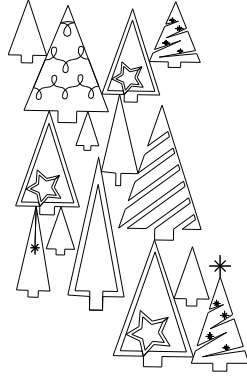
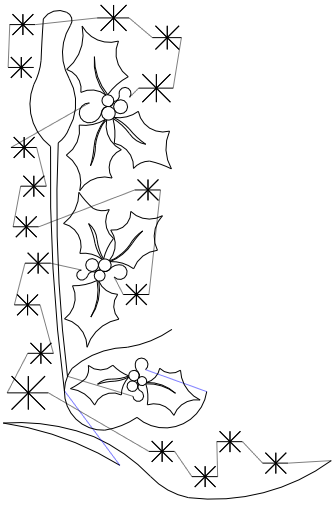

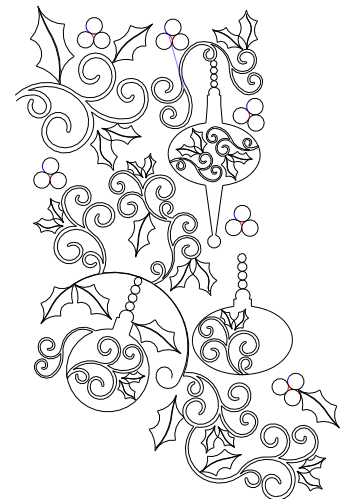
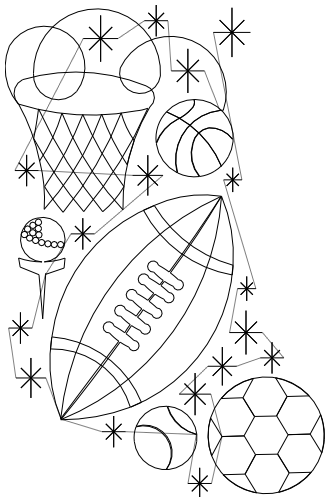
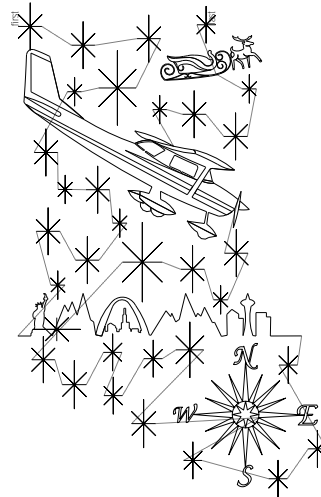
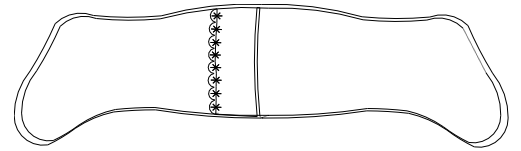
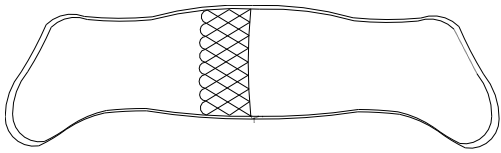

Christmas Stocking Mix and Match:
Choose the outline style you want and
fill it in with the design you want!

Christmas Tree Skirts have been re-designed so that you can make them bigger....and also so that if you have a smaller throat on your longarm, you can still make them. (need to make 10 panels for 1 skirt)

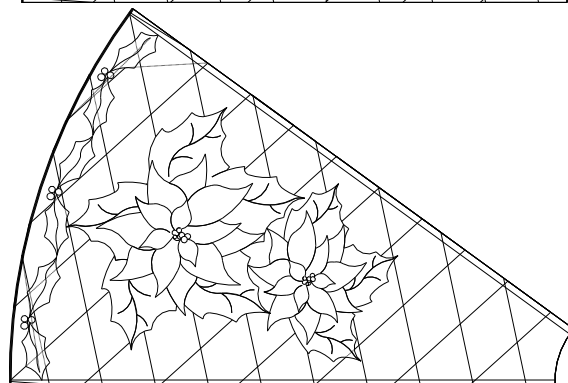
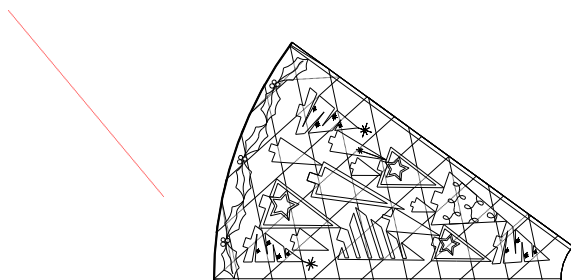
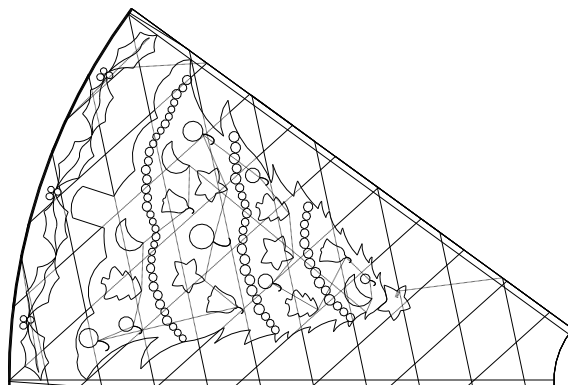
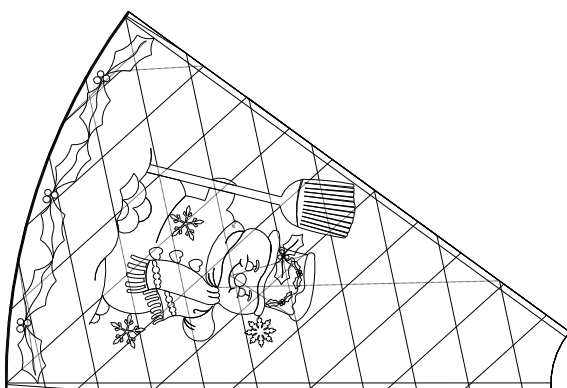
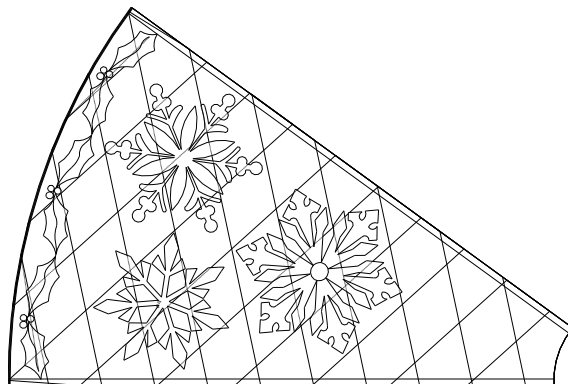
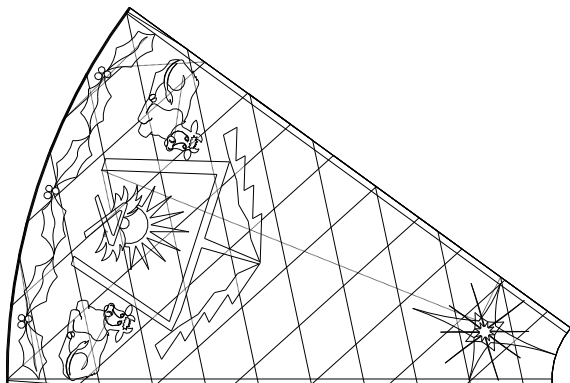
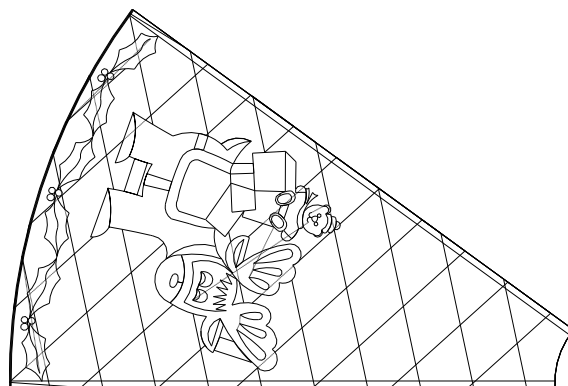
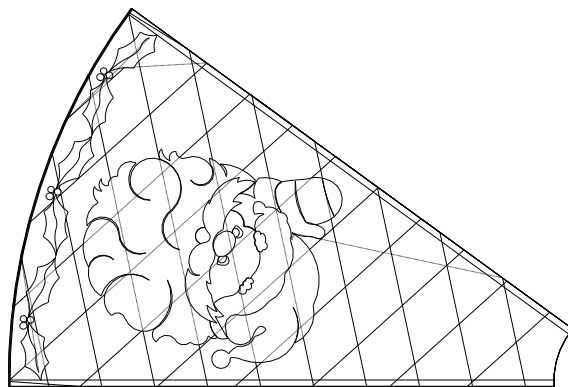
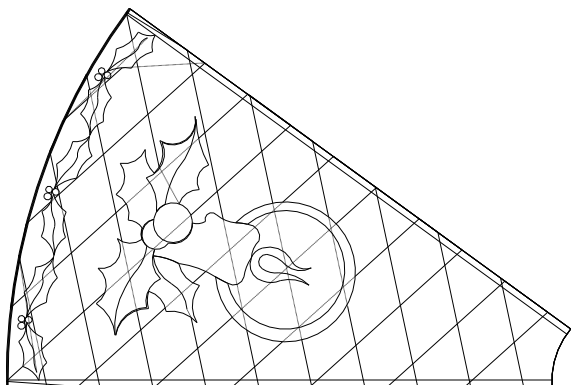

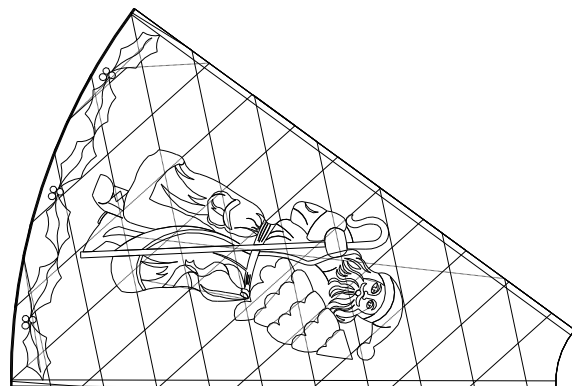
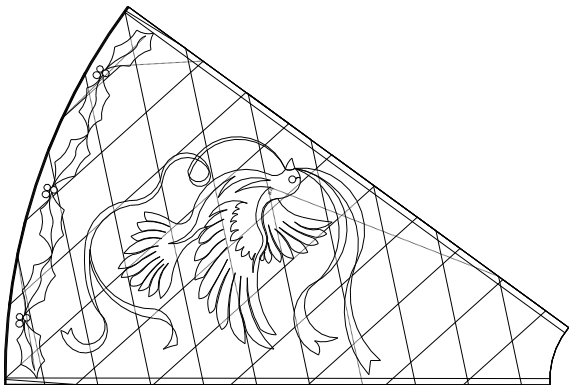
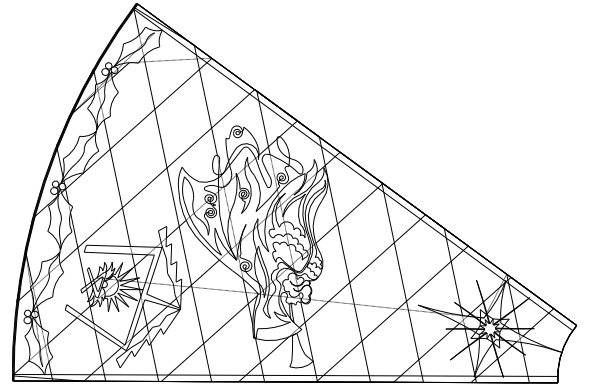
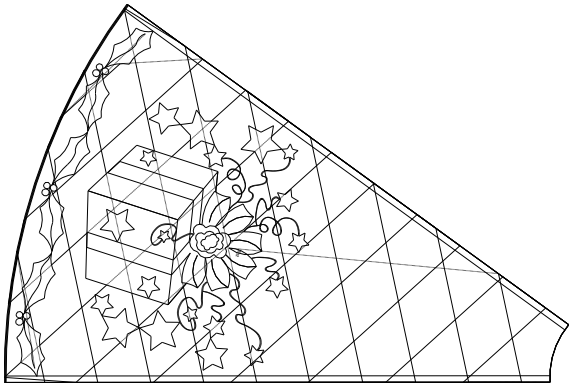
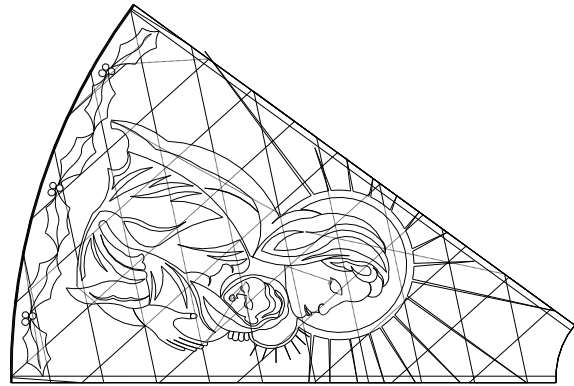
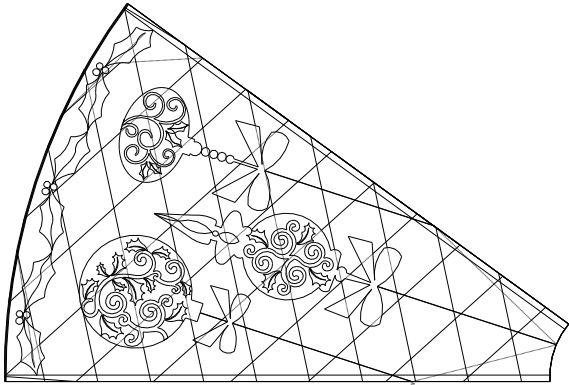
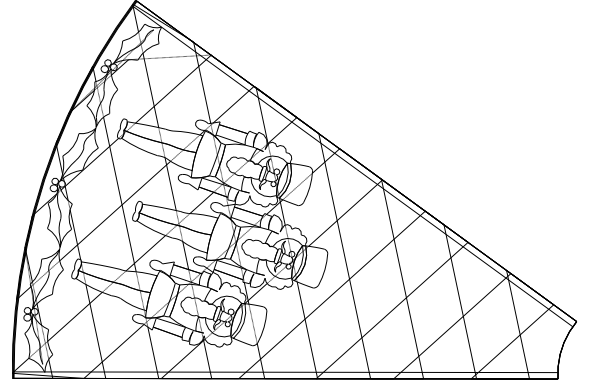
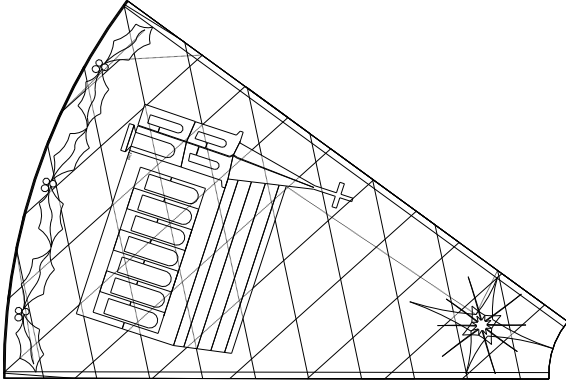
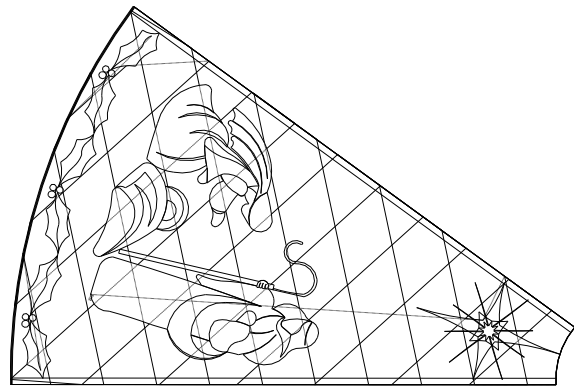

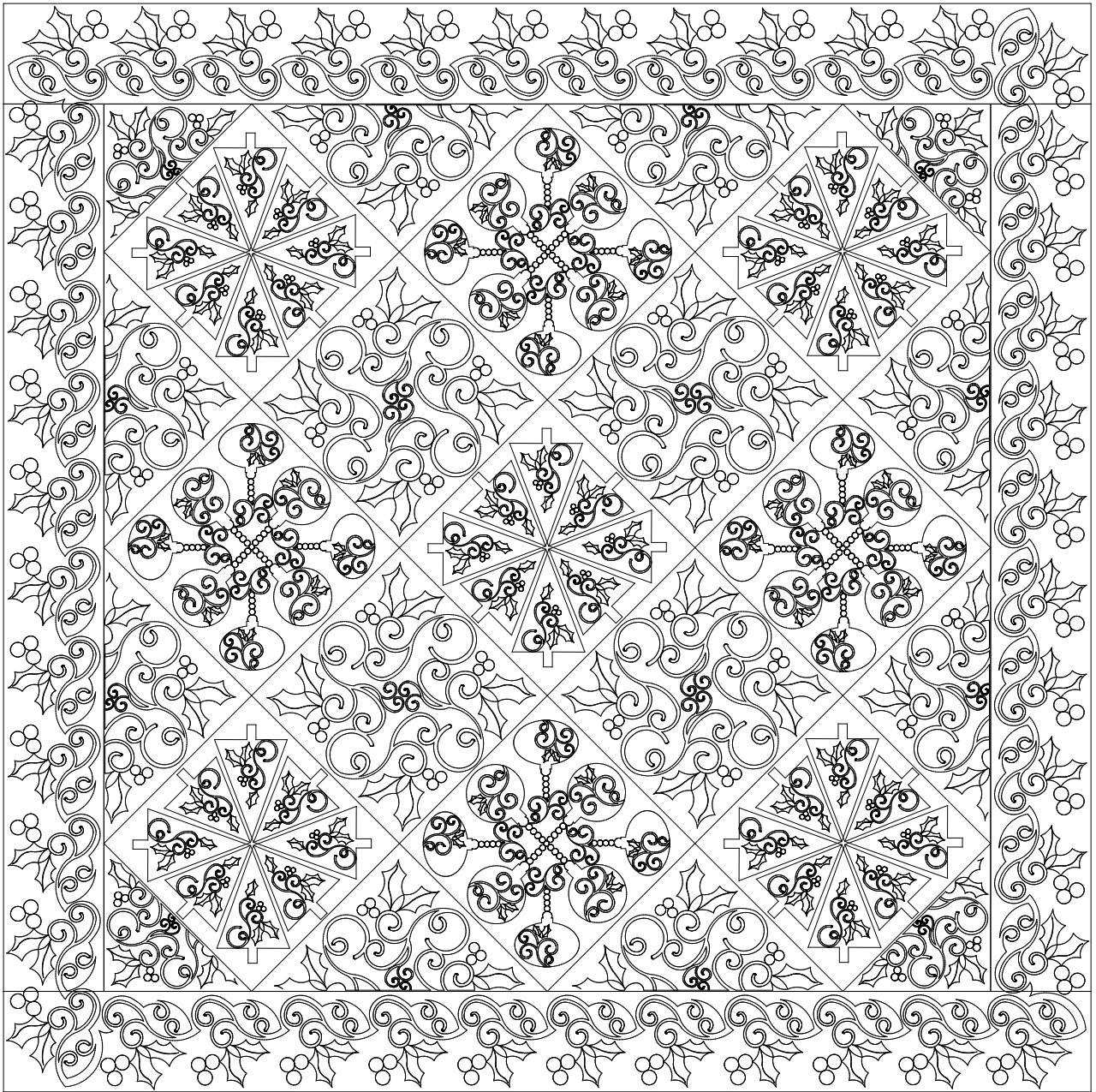

Christmas 2010 Pattern Set

Changes

Sweet Dreams Quilt Studio has made some pattern distribution changes lately, which only affect Statler Stitcher users. Beginning October 1st, no Pattern Bundles or Crown Jewels Club archives will be available for automatic download. Instead, those purchases will be emailed to you just as soon as we can get to them. The auto encryption system "iStatler" (developed by, owned by, and maintained by Gammill) was experiencing volume difficulties. Their solution was so costly that it was a convenience that we could no longer provide for Bundles and Archives without passing that cost along to our customers and we simply were not willing to do that. So regular pattern orders will continue to be available for auto download....you'll just have to wait a bit for the rest.

We do encourage all of you (not just Statler users) to join our Facebook group and watch for announcements about the Crown Jewels Club. You can also upload and display your quilting photos! Even photos of your quilt studios! We love to see it all!



Email Spam Tip:

If you are using an email program such as Outlook Express, Microsoft Outlook, etc. to manage your email, you already know about the "junk" folder that shows up listed under your Inbox. But did you know that your Internet Service Provider also has another spam/junk folder which collects emails before they ever reach your Outlook Express or MS Outlook? How do you find it? Go to the web page of your ISP (for example, my personal email account is with CenturyLink) So, I go to www.centurylink.com, and click on the "web mail" link. I have to enter my user name and password, but then I can see my emails even if I'm not using my own computer. I can also see that ISP provided spam box. Take a look through that spam/junk box and see if it has any of your missing emails in it. If it does, you should be able to mark those emails as "not junk". That will help future emails from those senders actually make it to your computer. I can do the same thing for my AOL email account....just go to the www.aol.com, log into web mail, and check out the junk/spam folders. It will surprise you what's in there!

